

Varenummer: 0108052
 Beskrivelse: Seeger låsering JK 35 DIN 984

Mål

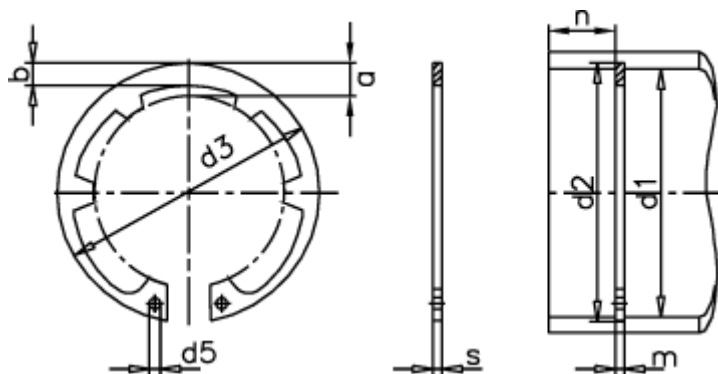

a max	= 5.5	d5 min	= 2.5	s	= 1.50
AN mm ²	= 113.0	FN kN	= 18.8	t	= 1.00
Antal takker	= 6	FRg kN	= 6.4	Tang	= ZGJ-2
b	= 3.6	FR kN	= 26.9	tol	= -0.06
Betegnelse	= JK 35	g	= 1.5	tol	= +0,50-0,25
d1	= 35	K kN-mm	= 50.5	tol	= +0,25
d2	= 37.0	m min	= 1.60	vægt kg/1000	= 4.00
d3	= 37.8	Nominal træk	= 3.0		